

泉州豐群電子有限公司

C.C. FENG CHIUN ELECTRONIC CO., LTD.

OFFICE: TEL:+886-2-82522781
FAX:+886-2-82522782

FACTORY: TEL:+86-595-22632579
FAX:+86-595-22632580

1	MODEL	31CP08M2-5(GP)
2	Dimension	Outer Diameter 31 mm Baffle Opening 28.4 mm.
		Height Refer to drawing Weight 12.7 Gram.
3	Magnet	Materials Rare Earth Size $\phi 12.5 \times 3.0$ mm.
4	Nominal Impedance	8 Ohm $\pm 15\%$
5	Power Rating	Normal 2.0 W. Maximum 4.0 W.
6	Lowest Resonant Frequency	330 \pm 66 Hz
7	Output Sound Pressure Level	82 \pm 3 db / 1 Watt 1 Meter.
		Average at 500,600,800,1000 Hz
8	Frequency Range	150~20K Hz. Average SPL-10 dB.
9	Distortion	5 % Maximum At 1000 Hz 2.0 W.
10	Abnormal Sound Test	Must be Normally Tested By 4.0 Volts Sine Wave.
11	Load Test	White Noise with Weighted Filter 4.0 Volts. (RMS) 96 Hrs.
12	Operation Temperature	-25°C ~ +70°C
13	Storage Temperature	-40°C ~ +85°C
14	Polarity	Diaphragm shall move Forward when Apply a Positive DC
		Current to the "+" or "Marked" Terminal.
15	Remarks	Above specifications on the strength of CNS4784 and CNS4785.

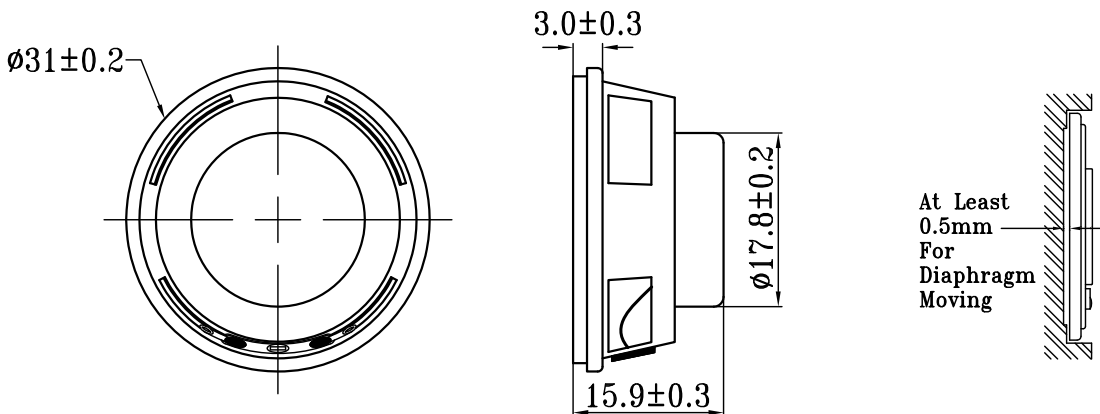
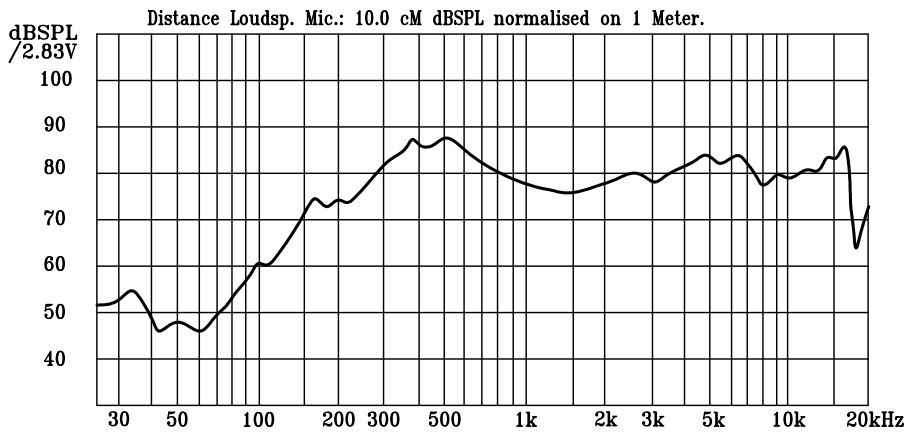

Unit:mm

Admitted:

Approved:

Made: