

泉州豐群電子有限公司

C.C. FENG CHIUN ELECTRONIC CO., LTD.

OFFICE: TEL:+886-2-82522781
FAX:+886-2-82522782

FACTORY: TEL:+86-595-22632579
FAX:+86-595-22639258

1	MODEL	1635CP08P1(GP)
2	Dimension	16.2X35.2X5.6H Weight 3.0 Gram.
3	Magnet	Materials Rare Earth Size $\phi 8.0 \times 1.5$ mm.
4	Nominal Impedance	8 Ohm $\pm 15\%$
5	Power Rating	Normal 1.0 W. Maximum 1.5 W.
6	Lowest Resonant Frequency	640 \pm 128 Hz
7	Output Sound Pressure Level	79 \pm 3 db / 1 Watt 1 Meter.
		Average at 800,1000,1200,1500 Hz
8	Frequency Range	400~20K Hz. Average SPL-10 dB.
9	Distortion	5 % Maximum At 1000 Hz 1.0 W.
10	Abnormal Sound Test	Must be Normally Tested By 2.83 Volts Sine Wave.
11	Load Test	White Noise with Weighted Filter 2.83 Volts. (RMS) 24 Hrs.
12	Operation Temperature	-25°C ~ +60°C
13	Storage Temperature	-40°C ~ +70°C
14	Polarity	Diaphragm shall move Forward when Apply a Positive DC
		Current to the "+" or "Marked" Terminal.
15	Remarks	Above specifications on the strength of CNS4784 and CNS4785.

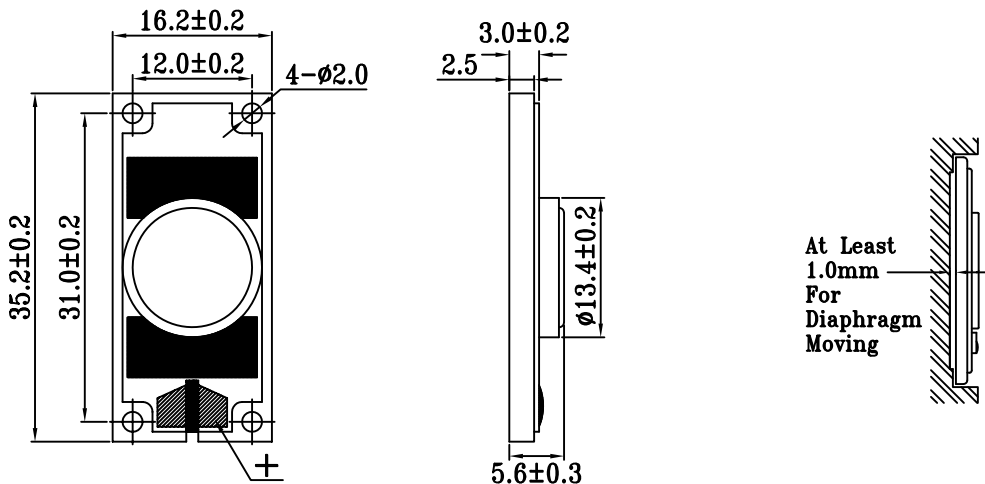
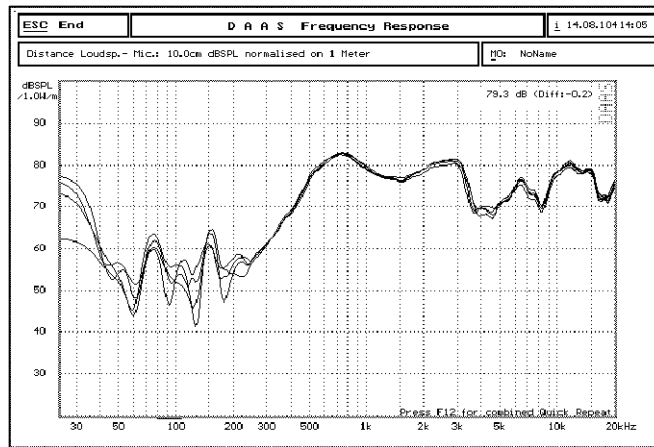

Unit:mm

Admitted:

Approved:

Made: